

4200, 5100

HAND DRAWN
WIDE CHANNEL

4200, 5100

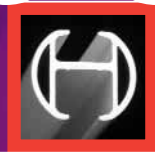

G-RAIL[®]

ALUMINIUM RAIL

> *by Goelst*



Profiles 4200 and 5100 have the essence of a classic curtain pole combined with the precision and comfort of an aluminium curtain rail.

This becomes clear with the smooth and almost silent movement of the curtains. Both profiles are easy to bend and with the introduction of a small return allow the curtains to draw back to the wall to exclude day-light. To complement today's stylish interiors, profiles and components are available in a range of attractive standard colours.

Standard colours: White Ral 9010, natural, brown, gold, natural polished, gold

**HAND DRAWN
WIDE CHANNEL**
4200, 5100



4200 and 5100 > de

Installation

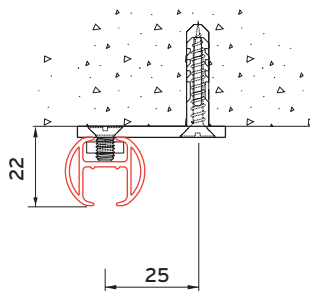

Ceiling fixing 4200
with bracket 5135

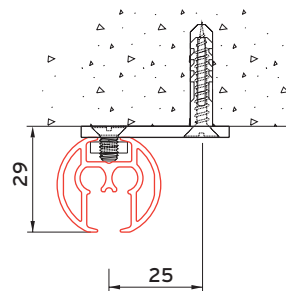

Ceiling fixing 5100
with bracket 5135

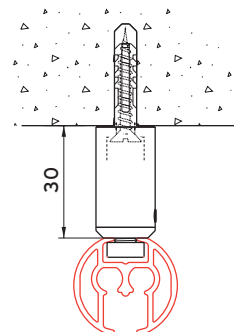

Ceiling fixing 5100
with mini-suspension
hanger 4254

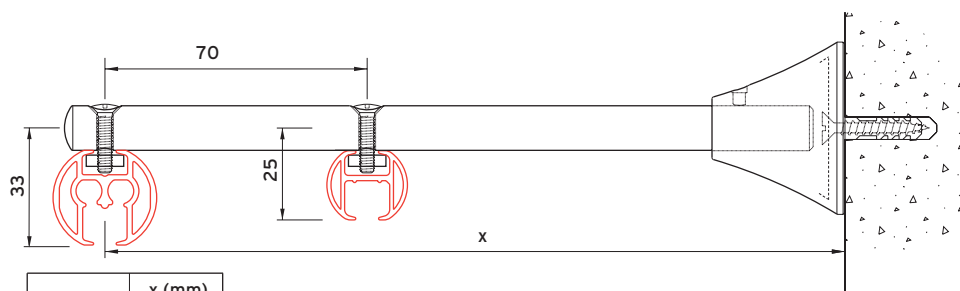

	x (mm)
4217-101	100
4217-201	200
4217-202	200

Face fixing with adjustable extension bracket 4217

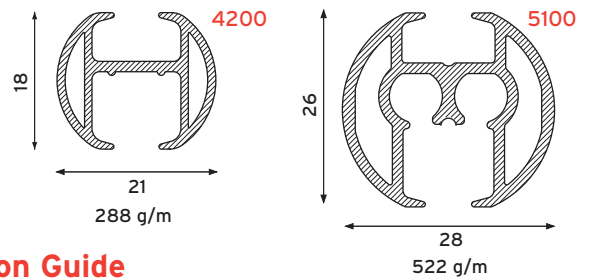

Specification Guide

Material:

Aluminium 606035-T6-F22. (Higher specification than DIN 1725).
 Shape and size tolerances are in accordance with DIN 17615.
 White RAL 9010 powder coated in accordance with the Qualicoat standard. Special colours on request.
 Profile weight 4200: 288 g/m. Profile weight 5100: 522 g/m.

Accessories:

Gliders 4010 at 10 - 16 per metre with 2 end stops 4001 and 2 end covers per length (4253 for 4200 or 5153 for 5100).

Installation:

End fixing with wall support 4249 for rail 4200 or wall support 5150 for rail 5100. Ceiling fixing with plate 5135 or mini-suspension hanger 4254. Wall fixing with wall bracket 4217 or 5115.

Bracket fixing centres (cm) in accordance with the G-Standard or the following table.

	light	medium	heavy (curtain)
4200:	100	80	60
5100:	180	130	100

Bending:

Minimum radius 15 cm. Bending machine 1015.

Id polished. Special colours on request.

decorative and profiles.

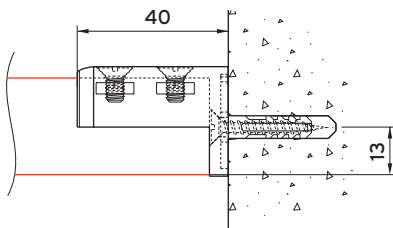

Wall fixing 5100
with wall support 5150

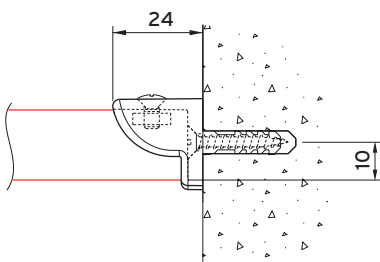

Wall fixing 4200
with wall support 4249

G-Standard (bracket fixing guide)

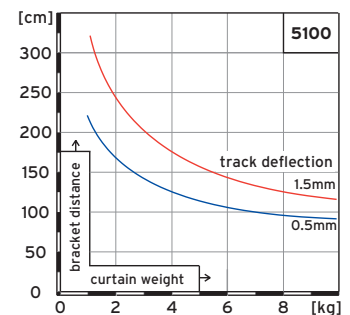
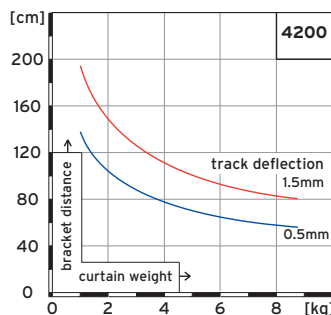

Application example (5100)



5153-100-KGM
matt gold finial

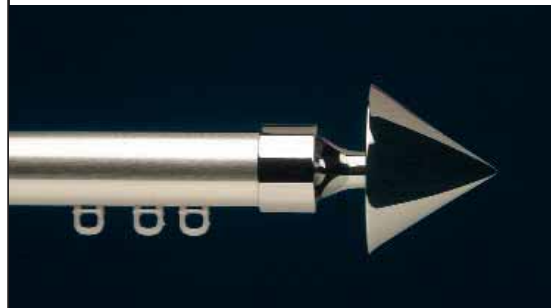

5153-200-KNC
natural chrome finial

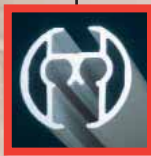

Application example

5100 with heading

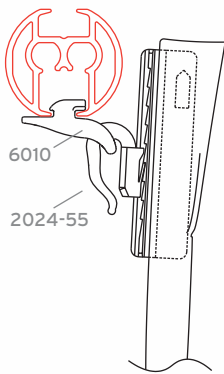

5100 without heading

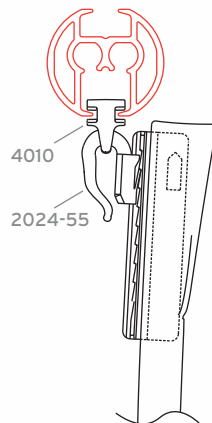

Uprand headings can be achieved by using projection glider 6010. This glider can only be used on a straight track up to 6 metres long and with a maximum curtain weight of 8 kg.

Combination example

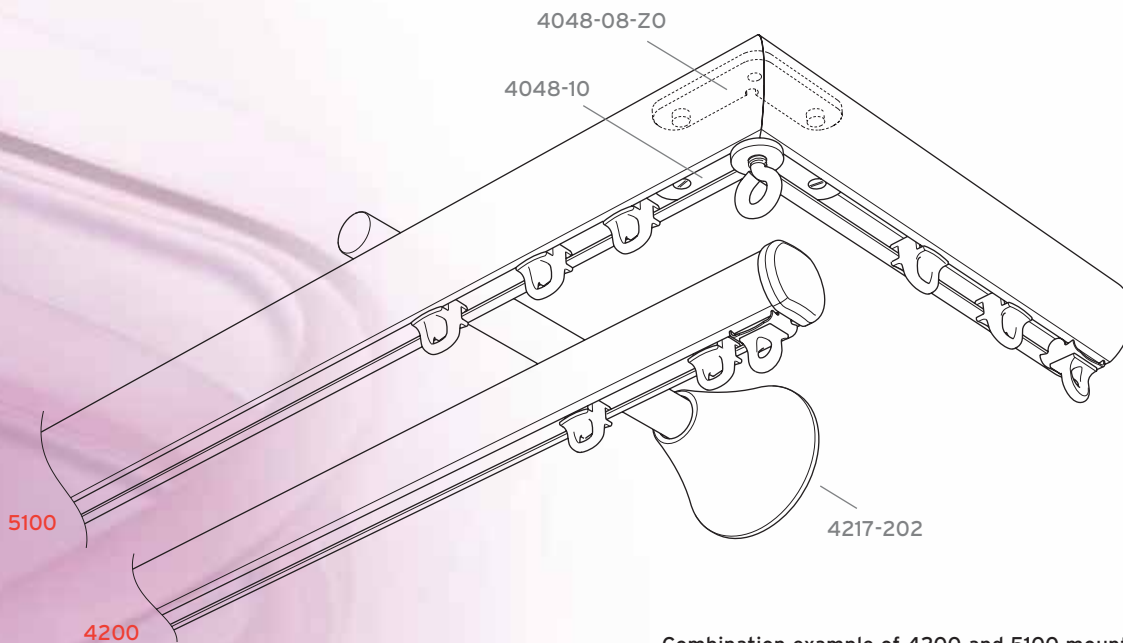

















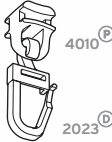
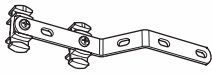

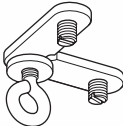





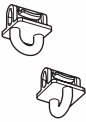
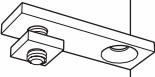



Combination example of 4200 and 5100 mounted on an adjustable extension bracket 4217-202.

A wall return is created using corner connectors 4048-10 and 4048-08-ZO.

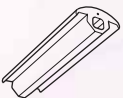

G-Rail systems 7300 (panel track) and 7900 (roman blinds) can be placed instead of rail 4200.

Components

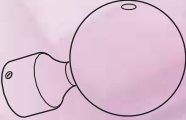
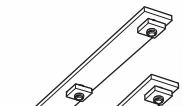
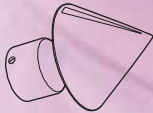
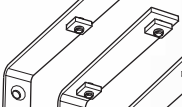
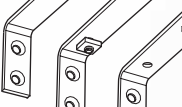
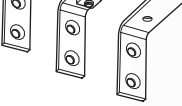
Product design and specification changes reserved.

CURTAIN TRANSPORT								
	4001 endstop colours: B - G - W		2021 G-hook		4249 synth. wall bracket B - G - GR - W for 4200		5150 for 5100	
	4001-A endstop with eye (metal)		2022 curtain hook	ACCESSORIES				
	4002 endstop		4025 glider 4010 with hook 2023		5080 overlap carrier - to be used in combination with a drawrod:			
	4003 spring stop		4048-10 corner connection with eye		7399-K plexi drawrod with core			
	4007 rotating glider	CEILING FIXING			7399 plexi drawrod			
	4010 [®] glider (on strip) colours: B - G - W - ZW		4254 mini-suspension hanger - 3 cm colours: B - G - N - W		7399-WK steel drawrod white synthetic cover			
	4012-10 click glider 4012-40: click glider transversed		5135 ceiling bracket colours: N - W		4253 synth. endcap B - G - GR - W for 4200		5153 for 5100	
	4012-50 click glider transversed with hook	WALL FIXING			4253-A aluminium endcap GM - NM for 4200		5153-A for 5100	
	4030 roller colours: B - G - W - ZW		4217-202 [®] 20 cm		4145 dust-cover to close and seal gap when using 4135 fixing plates colours: B - GR - W			
	6010 [®] projection glider		4217-201 [®] 20 cm		5152 internal connecting bridge			
	2020 double hook		4217-101 [®] 10 cm		5153-100 finial for 5100 colours: KGG-KGM-KNC			
HAND DRAWN WIDE CHANNEL # 4200, 5100			5115-15		5153-200 finial for 5100 colours: KGG-KGM-KNC			
			5115-10					
			5115-07,5					
			extensio n bracket (16x3mm) colours: N - W					

- B = Brown
- G = Gold
- GM = Gold metallic
- GR = Grey
- N = Natural
- NM = Natural metallic
- W = White
- ZW = Black
- KGG = Bright gold
- KGM = Matt gold
- KNC = Natural Chrome

-  = Standard item
-  = Registered design
-  = Patented design

G-RAIL®

Unless stated otherwise, all components are suitable for both 4200 and 5100.

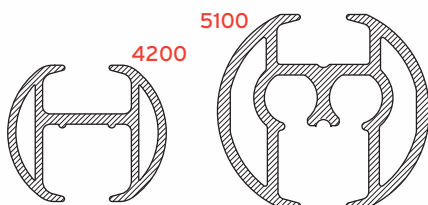

Space for dealer address