

2200-series

HAND DRAWN
SMALL CHANNEL

2200-SERIES



Opal

ALUMINIUM RAIL



G-Rail 2200 is suitable for medium weight curtains and can be mounted to most fixing surfaces. Offering a variety of mounting brackets this rail provides many practical fixing solutions and can be curved to a minimum radius of 10 cm.

Colours 2200: White RAL 9010, natural, brown, gold. Special colours on request.

Colours 2201: White RAL 9010, natural.

2200 > For medium weight

HAND DRAWN
SMALL CHANNEL

2200-SERIES



Installation

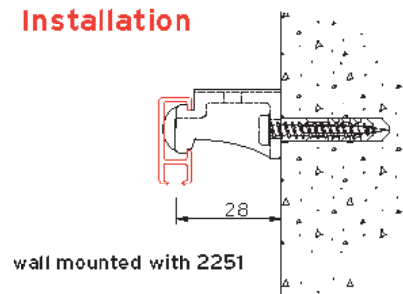

wall mounted with 2251

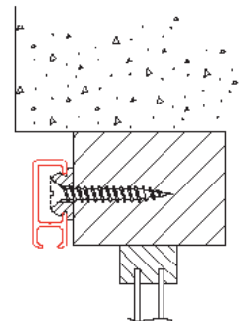

secret fixing with button clip 2254

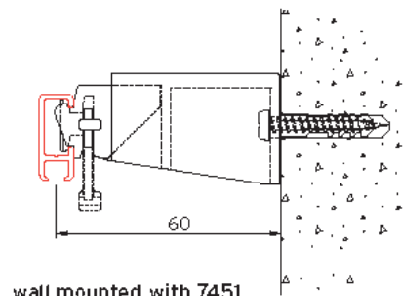

wall mounted with 7451

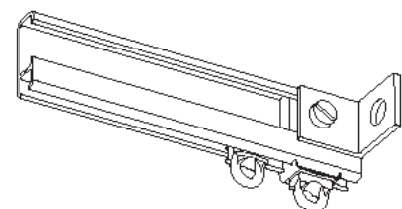

wall mounted with 2249-N

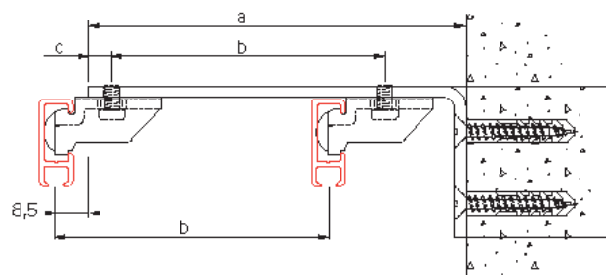

wall mounted with extension bracket 2015-10

	[mm]			
	a	b	c	d
2015-05	50	-	6,5	40
2015-07,5	75	47	6,5	40
2015-10	100	72	6,5	40
2015-15	150	72	6,5	40
2018-15	150	57 / 57	6	80
2019-20	200	80	6,5	60
2019-25	250	80	6,5	60
2019-30	300	80	6,5	60



Extension bracket	Load (kg)		
	1	2	4
2015-15	2	5	10
2018-15	1	2	4

Deflection (in mm) of the bracket 2015-15 and the stronger bracket 2018-15

Specification Guide

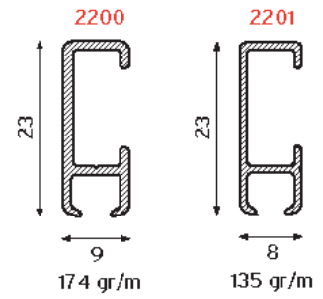

Material:

Aluminium 606035-T6-F22. (Higher specification than DIN 1725).
Shape and size tolerances are in accordance with DIN 17615.
Satin silver anodised or powder coated in accordance with the Qualicoat standard. Special colours available on request.
Profile weight 2200: 174 gr/m. Profile weight 2201: 135 gr/m.

Accessories:

Gliders 2010 at 16 per metre with 2 end stops 2001 and 2 end covers 2253 per length.

Installation:

Face fixing with nylon bracket 2251 or 7451 / ceiling fixing with nylon bracket 2250 or 7450 each screwed to timber or plugged and screwed to blockwork.

Bracket distance (cm) according to G-Standard or the following table.

	light	medium	heavy (curtain)
2200	110	80	55
2201	95	65	45

Bending:

Minimum radius 10 cm. Using bending machine 1012 or 1015.

G-Standard (bracket fixing guide)

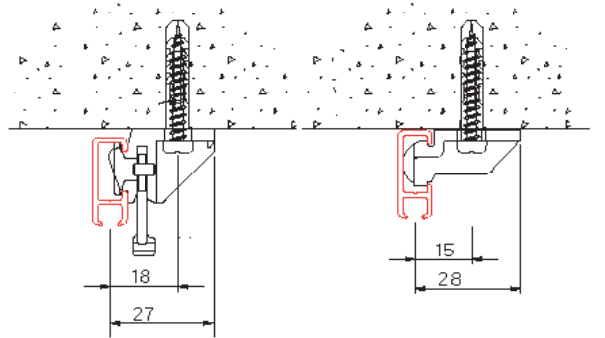
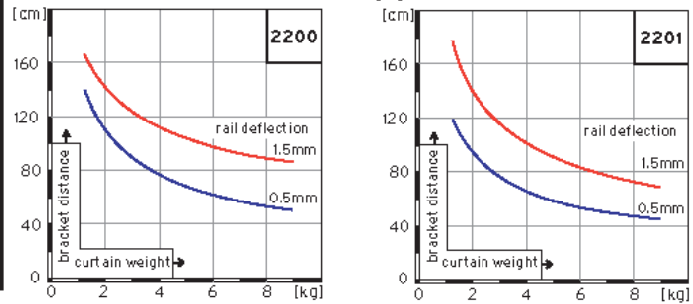

ceiling mounted with 7450 ceiling mounted with 2250

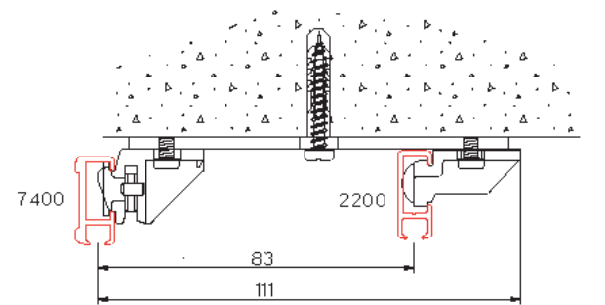

ceiling mounted with double bracket 2216 and 7450 or 2250





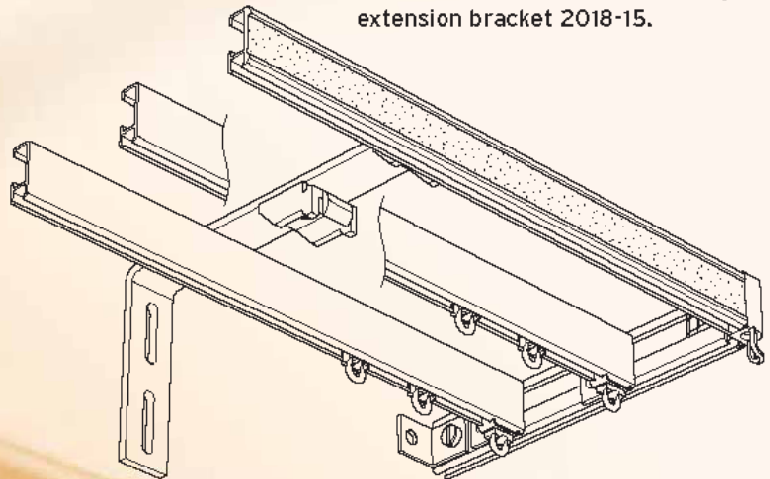







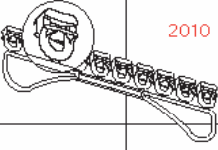
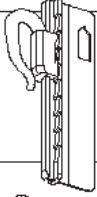
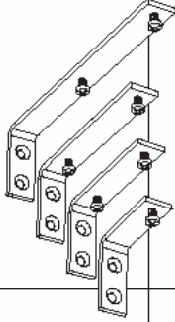



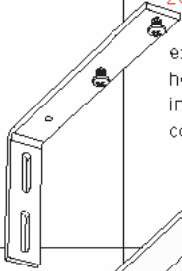

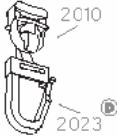
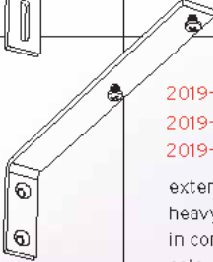

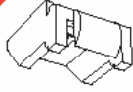

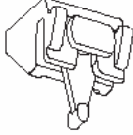

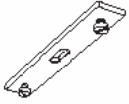
Combination example

Valance rail incorporating single or double rail 2200 (for sheers and / or main drapes) combined with 7400 Velcro rail, assembled using extension bracket 2018-15.

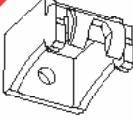
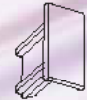

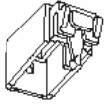

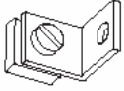
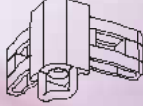
Components

Product design and specification changes reserved.

CURTAIN TRANSPORT					
	2001 twist end stop colours: B - G - W		2022 curtain hook		2254 button clip
	2010 glider colours: B - G - W		2024-55 sew in hook 55 mm		2015-15 2015-10 2015-07,5 2015-05 extension bracket (16X3mm) in comb. with 2250 / 7450 colours: N - W
	2001-A metal end stop		2023  curtain hook for 2025		2018-15 extension bracket (20X4mm) heavy duty in comb. with 2250 / 7450 colours: N - W
	2002 screw twist end stop		2025 glider 2010 with curtain hook 2023		2019-20 2019-25 2019-30 extension bracket (20X4mm) heavy duty in comb. with 2250 / 7450 colours: N - W
	2003 spring stop	CEILING MOUNTING			
	2011 glider with SS hook colours: B - G - W		2250 ceiling fixing bracket colours: B - G - W		
	2012-10 click glider		7450 ceiling fixing bracket colours: B - W		
	2012-40 click glider transversed		2216 double fixing bracket in combination with 2250 / 7450 colours: N - W		
	2012-50 click glider transversed with hook		2050-SYST T-bar clip for ceiling grid in comb. with 2250	ACCESSORIES	
	2020 double hook		2251 wall fixing bracket 3cm colours: B - G - W		2253 end cap colours: B - G - GR - W
	2021 G-hook curtain hook		7451 wall fixing bracket 6cm colours: B - W		2252 connecting bridge
			2249-N 90° metal angle bracket colours: N - W		2248 nylon corner connector colours: GR - W
					2248-N metal corner connector

**HAND DRAWN
SMALL CHANNEL
2200-SERIES**

B = Brown
G = Gold
N = Natural
W = White
GR = Grey

 = Standard item
 = Registered design
 = Patented design

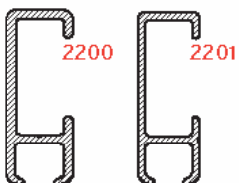

Space for dealer address

03/2004